

FALCON

Activation sensor for automatic industrial doors*

FALCON: for normal to high mounting (11.5 - 23 ft)

FALCON XL: for low mounting (6.5 - 11.5 ft)

FALCON WIDE: for wide detection field

DESCRIPTION

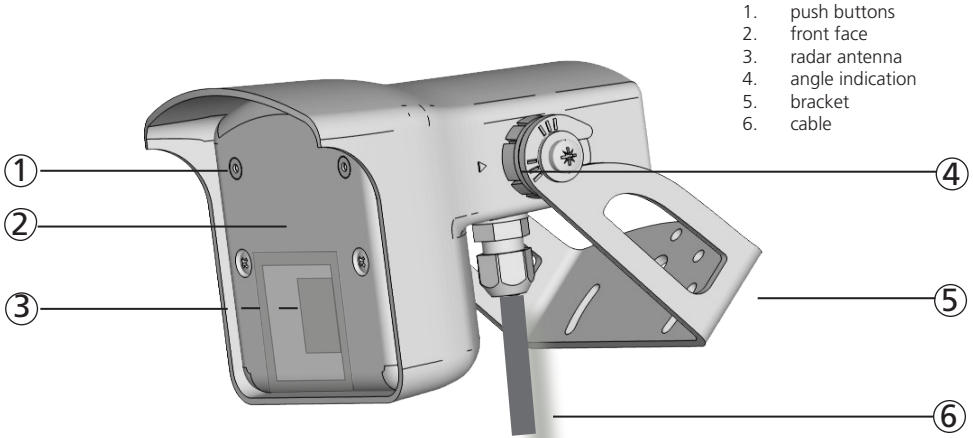

TECHNICAL SPECIFICATIONS

Technology:	microwave doppler radar
Transmitter frequency:	24.150 GHz
Transmitter radiated power:	< 20 dBm EIRP
Transmitter power density:	< 5 mW/cm ²
Detection mode:	motion
Detection zone:	FALCON: 13 x 16 ft @ 16ft ; FALCON XL: 13 x 6.5 ft @ 8.2ft; FALCON WIDE: 30 x 11 ft @ 21 ft. (typical at 30° and field size 9)
Min. detection speed:	2 in/s**
Supply voltage:	12V to 24V AC ±10%; 12V to 24V DC +30% / -10%
Mains frequency:	50 to 60 Hz
Max power consumption:	< 2 W
Output:	relay (free of potential change-over contact)
Max. contact voltage:	42V AC/DC
Max. contact current:	1A (resistive)
Max. switching power:	30W (DC) / 60VA (AC)
LED-signal:	red: detection state, parameter indication; green: value indication
Mounting height:	FALCON: 11.5 - 23 ft; FALCON XL: 6.5 - 11.5 ft; FALCON WIDE: 11.5 - 21 ft
Degree of protection:	IP65
Temperature range:	from -22 °F to + 140 °F
Dimensions:	5 in (L) x 4 in (H) x 3.75 in (W)
Tilt angles:	0° to 180° vertical
Materials:	ABS and polycarbonate
Weight:	14 oz
Cable length:	33 ft
Norm conformity:	R&TTE 1999/5/EC; EMC 2004/108/EC

Specifications are subject to changes without prior notice.

* Other use of the device is outside the permitted purpose and can not be guaranteed by the manufacturer.

** Measured in optimal conditions

For more information, please visit www.devancocanada.com
or call toll free at 855-931-3334

1 MOUNTING & WIRING

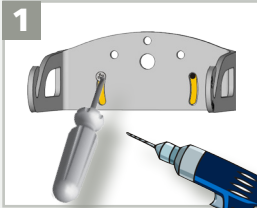

Remove the bracket from the sensor.
Drill 2 holes accordingly.
Mount the bracket firmly.

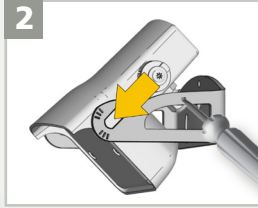

Position the sensor on the bracket and fasten the screws firmly.

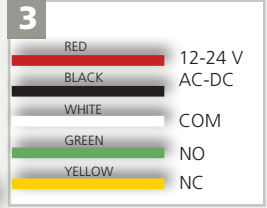

Connect the wires to the door controller. Choose between NO and NC contact.

2 DETECTION FIELD ADJUSTMENTS

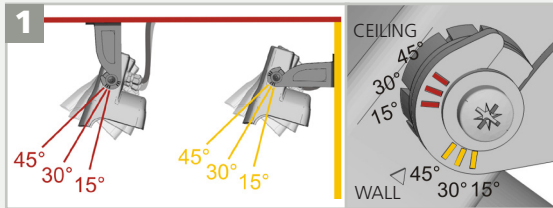

Adjust the angle of the sensor to position the detection field.

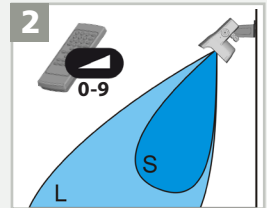

Adjust the field size with the remote control or the push buttons.

FALCON
Mounting height: **16 ft**

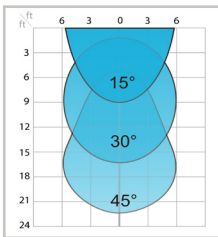

FALCON XL
Mounting height: **8 ft**

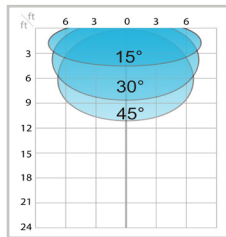

FALCON WIDE
Mounting height: **11.5 ft**

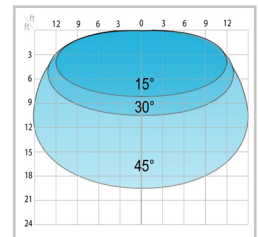

All detection field dimensions were measured in optimal conditions and with field size value 9.

3 DETECTION FILTER (REJECTION MODE)

Choose the right detection filter for your application with the remote control or the push buttons:



Detection of all targets
(pedestrians and parallel traffic are detected)

- 1 = no specific filter
- 2 = filter against disturbances
(recommended in case of vibrations, rain etc.)

Detection only of vehicles moving towards the sensor*
(pedestrians and parallel traffic are not detected + disturbances are filtered)

Value recommendations according to angle and height:

	23 ft - 11.5 ft	8 ft
15°	3	3
30°	4	4
45°	5	4
+45°	6	5
		XL

Always check if the chosen value is optimal for the application.
The object size and nature can influence the detection.

* The vehicle detection filter increases the response time of the sensor.

MOUNTING TIPS

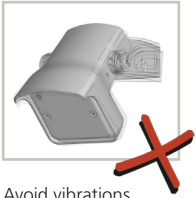

Avoid vibrations.

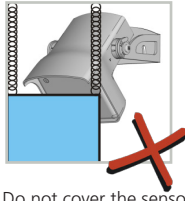

Do not cover the sensor.

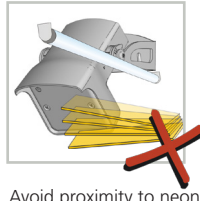

Avoid proximity to neon lamps or moving objects.



Only open the sensor when the cable needs to be replaced.

DIMENSIONS (inches)

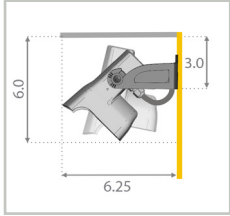

Wall mounting

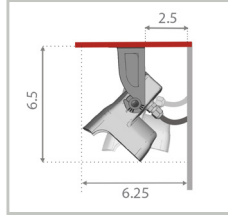

Ceiling mounting

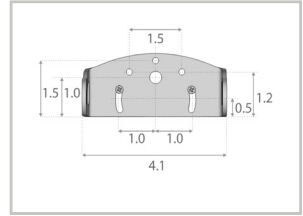

Bracket dimensions

POSSIBLE SETTINGS BY REMOTE CONTROL



FIELD SIZE



XXS

XS

S

>

>

>

>

L

XL

XXL

HOLD-OPEN TIME



0.5 s

1 s

2 s

3 s

4 s

5 s

6 s

7 s

8 s

9 s

OUTPUT CONFIGURATION



A

P

A = active output (relay active when detection)
P = passive output (relay active when no detection)

DETECTION MODE



bi

uni

uni
AWAY

bi = two-way detection
uni = one-way detection towards sensor
uni AWAY = one-way detection away from sensor

DETECTION FILTER



1

2

3

4

5

6



FACTORY VALUES

RESETTING TO FACTORY VALUES:



POSSIBLE SETTINGS BY PUSH BUTTONS



TO START OR END AN ADJUSTMENT SESSION, press and hold **either** push button until the LED flashes or stops flashing.



TO SCROLL THROUGH THE PARAMETERS, press the **right** push button.



TO CHANGE THE VALUE OF THE CHOSEN PARAMETER, press the **left** push button.



TO RESET TO FACTORY VALUES, press and hold **both** push buttons until both LEDs flash.

	Parameter n°	Value (factory values)
1	FIELD SIZE	(7)
2	HOLD-OPEN TIME	(0)
3	OUTPUT CONFIGURATION	(1)
4	DETECTION MODE	(2)
5	DETECTION FILTER	(1)

ACCESS CODE

The access code (1 to 4 digits) is recommended to set sensors installed close to each other.

SAVING AN ACCESS CODE:



Once you have saved an access code, you always need to enter this code to unlock the sensor.

DELETING AN ACCESS CODE:



ERASE AN UNKNOWN ACCESS CODE:

If you do not know the access code, **cut and restore the power supply**. During 1 minute, you can erase an unknown access code:



TROUBLESHOOTING

	The door remains closed. The LED is OFF.	The sensor power is off.	1 Check the wiring and the power supply.
	The door does not react as expected.	Improper output configuration on the sensor.	1 Check the output configuration setting on each sensor connected to the door operator.
	The door opens and closes constantly.	The sensor is disturbed by the door motion or vibrations caused by the door motion.	1 Make sure the sensor is fixed properly. 2 Make sure the detection mode is unidirectional. 3 Increase the tilt angle. 4 Increase the detection filter value. 5 Reduce the field size.
	The door opens for no apparent reason.	The sensor detects raindrops or vibrations.	1 Make sure the detection mode is unidirectional. 2 Increase the detection filter value.
	The vehicle detection filter is used, but pedestrians are still detected.	In highly reflective environments, the sensor detects objects outside of its detection field.	1 Change the antenna angle. 2 Decrease the field size. 3 Increase the detection filter value.
	The LED flashes quickly after unlocking.	The chosen value is not optimal for this application.	1 Increase the detection filter value. 2 Decrease the sensor angle. 3 Increase the installation height. 4 Make sure the detection mode is unidirectional.
	The sensor does not respond to the remote control.	The sensor needs an access code to unlock.	1 Enter the right access code. 2 If you do not know the access code, cut the power supply and restore it to access the sensor and change the access code or delete it.
	The sensor does not respond to the remote control.	The remote control batteries are weak or improperly installed.	1 Check the batteries and change them if necessary.



SAFETY INSTRUCTIONS

The manufacturer of the door system is responsible for carrying out a risk assessment and installing the sensor and the door system in compliance with applicable national and international regulations and standards on door safety. Only trained and qualified personnel may install and setup the sensor. The warranty is void if unauthorized repairs are made or attempted by unauthorized personnel.



BEA hereby declares that the FALCON is in conformity with the basic requirements and the other relevant provisions of the directives 1999/5/EC and 2004/108/EC.



The complete declaration of conformity is available on our website: www.bea.be

Only for EC countries: According the European Guideline 2012/19/EU for Waste Electrical and Electronic Equipment (WEEE)



For more information, please visit www.devancocanada.com or call toll free at 855-931-3334