

**Parts Catalog / Catalogue pièces**

**SPARE PARTS  
PIÈCES DÉTACHÉES  
BL229**

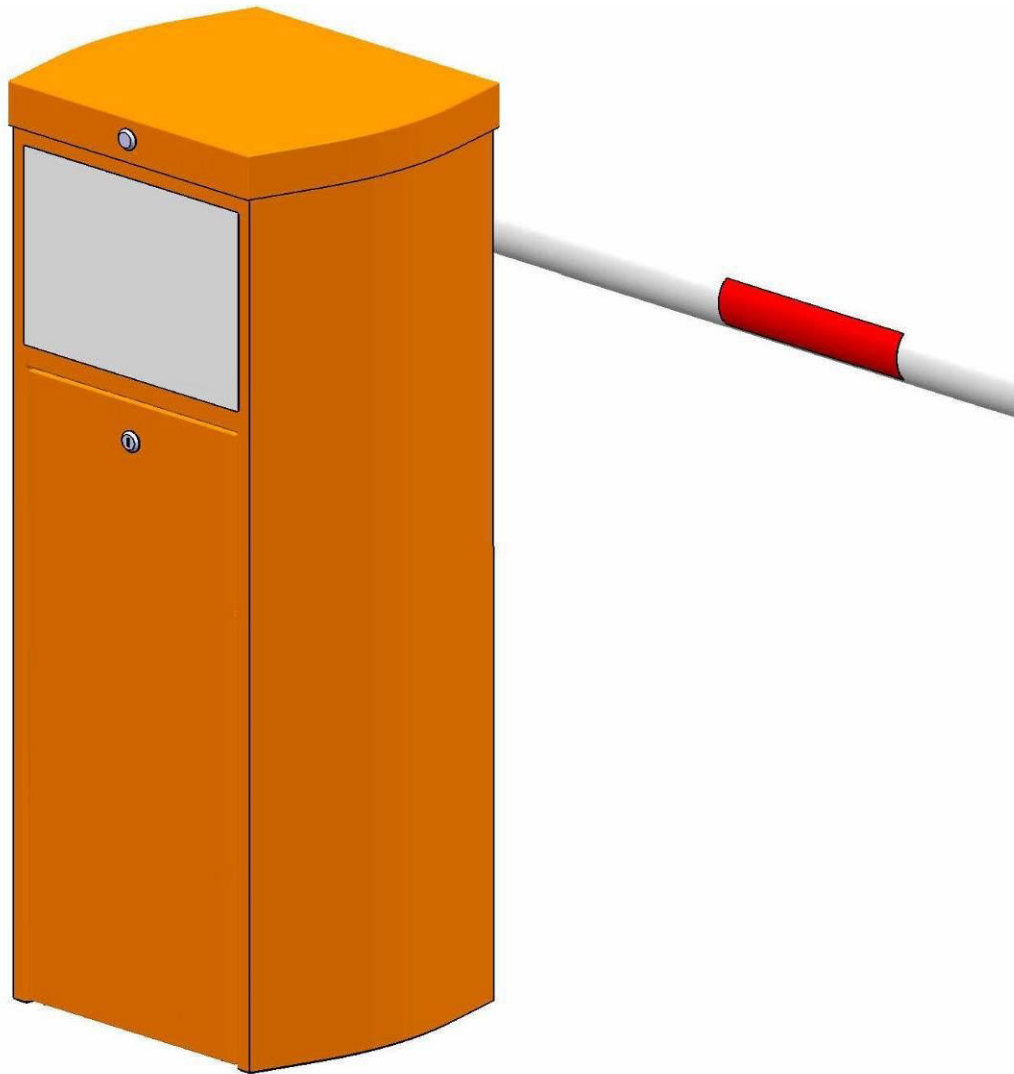

**For more information, please visit [www.devancocanada.com](http://www.devancocanada.com)  
or call toll free at 855-931-3334**

LOCATE THE SERIAL NUMBER OF YOUR BARRIER ON  
THE IDENTIFICATION PLATE

TROUVEZ LE NUMÉRO DE SÉRIE DE VOTRE BARRIÈRE  
SUR LA PLAQUE D'IDENTIFICATION

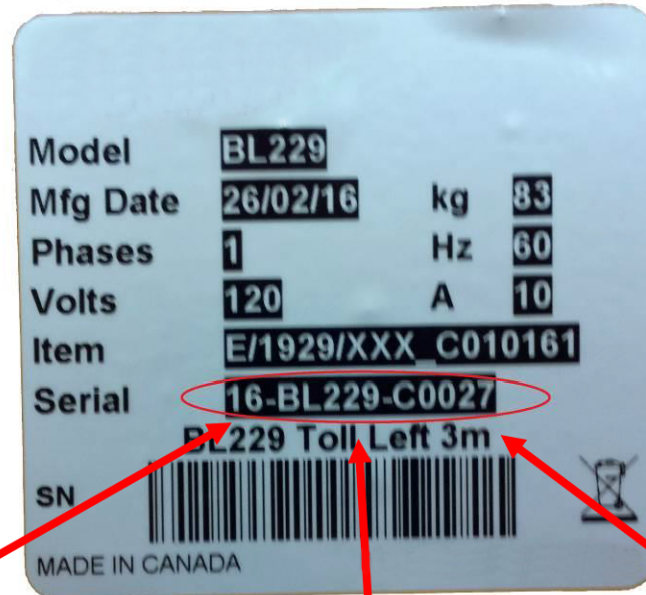

Year of Manufacture Année de Fabrication	Model Modèle	Sequence Number Numéro de Séquence
2016	BL229	C0027

For more information, please visit [www.devancocanada.com](http://www.devancocanada.com)  
or call toll free at 855-931-3334

## COMPONENTS LOCALISATION LOCALISATION DES COMPOSANTES

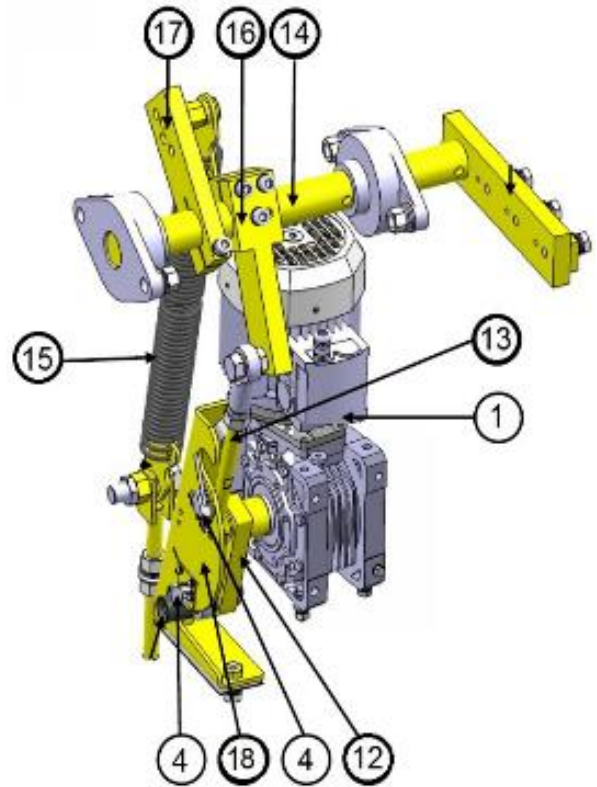
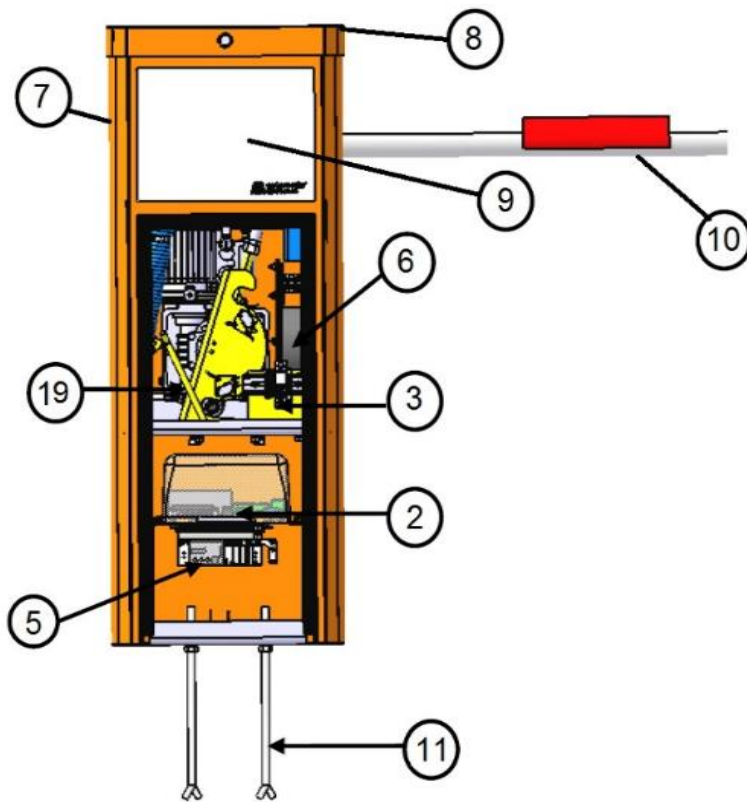





- 1- Gear Motor / Motoréducteur
- 3- Circuit Breaker 10A / Disjoncteur 10A
- 5- Frequency Drive / Variateur De Fréquence
- 7- Housing / Fût
- 9- Lexan Face Panel / Face en Lexan
- 11- Installation Plate Assy. / Ens. Cadre à Sceller
- 13- Rod Assembly / Ensemble Bielle
- 15- Spring Assembly / Ensemble Ressort
- 17- Spring Lever / Mâchoire Ressort
- 19- Manual Unlocking Assembly / Ensemble Déverrouillage Manuel





- 2- AS1320 Board / Carte AS1320
- 4- Limit Switches / Capteurs Fin De Courses
- 6- Transformer / Transformateur
- 8- Hood With Lock / Capot Avec Serrure
- 10- Gate Arm / Lisse
- 12- Gear Motor Axis / Axe Réducteur
- 14- Axis Assembly / Ensemble Axe
- 16- Rod Lever / Mâchoire Bielle
- 18- Bumper Assembly / Ensemble Butée

**For more information, please visit [www.devancocanada.com](http://www.devancocanada.com)  
or call toll free at 855-931-3334**





# ELECTRICAL PARTS PIÈCES ÉLECTRIQUES

	<p>Standard Gearmotor Assembly Ensemble Motoréducteur Standard</p>	<p>EA1929/064</p>
	<p>Toll Gate Gearmotor Assembly Ensemble Motoréducteur Autoroute</p>	<p>EA1929/090</p>
	<p>AS1320 Board Assembly With Cover For BL229</p> <p>Ensemble Logique AS1320 Avec Couvercle Pour BL229</p>	<p>SA1929/032</p>
	<p>AS1321 Option Board Option Carte Interface AS1321</p>	<p>E/BLOP/129</p>
	<p>Single Channel Loop Detector Détecteur Boucle Simple</p>	<p>E/BLOP/127</p>
	<p>Dual Channel Loop Detector Détecteur Boucle Double</p>	<p>E/BLOP/128</p>



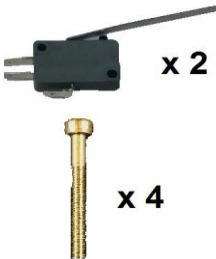

**For more information, please visit [www.devancocanada.com](http://www.devancocanada.com)  
or call toll free at 855-931-3334**

	<p>Main Circuit Breaker 10A Disjoncteur Principal 10A</p>	<p>0/7600/509</p>
	<p>Heater Circuit Breaker 5A Disjoncteur de Chauffage 5A</p>	<p>0/1918/310</p>
	<p>Strip Heater For Logic Board 120V Élément Chauffant Pour Logique 120V</p> <p>Strip Heater For Logic Board 240V Élément Chauffant Pour Logique 240V</p>	<p>E/BLOP/140</p> <p>E/BLOP/261</p>
	<p>Fan Heater Chauffage À Air Pulsé</p>	<p>0/7600/557</p>
	<p>Fan Heater Option Option Chauffage À Air Pulsé</p>	<p>E/BLOP/246</p>
	<p>Transformer 120V/240V 500VA Transformateur 120V/240V 500VA</p>	<p>0/7534/438</p>



For more information, please visit [www.devancocanada.com](http://www.devancocanada.com)  
or call toll free at 855-931-3334

	<p>Adjustable Heating Thermostat Thermostat De Chauffage Ajustable</p>	<p>0/7600/746</p>
	<p>Relay Assembly For AS1320 Board Ensemble De Relais Pour Logique AS1320</p>	<p>SA1907/054</p>
	<p>Analog Sensor Assembly Ensemble Capteur Analogique</p>	<p>E/1929/237</p>
	<p>Limit Switch Assembly Ensemble Interrupteur Fin De Course</p>	<p>E/1929/201</p>
	<p>Double Limit Switch Option Option Fin De Course Double</p>	<p>E/BLOP/118</p>

For more information, please visit [www.devancocanada.com](http://www.devancocanada.com)  
or call toll free at 855-931-3334

	<p>Breakaway Round Arm Detection Option Option Détection Lisse Ronde Dégondée</p>	<p>E/BLOP/318</p>
	<p>Breakaway Oval Arm Detection Option Option Détection Lisse Ovale Dégondée</p>	<p>E/BLOP/170</p>
	<p>1 Kit Of Two LED Lights For Arm 1 Ensemble De Deux Lumières LED Pour Lisse</p>	<p>E/BLOP/121</p>
	<p>2 Kits Of Two LED Lights For Arm 2 Ensembles De Deux Lumières LED Pour Lisse</p>	<p>E/BLOP/122</p>
	<p>Red LED Lighting Module For Arm Module Éclairage DEL Rouge Pour Lisse</p>	<p>0/7601/423</p>
	<p>Safety Edge Palpeur De Sécurité</p>	
	<p>3.0 m (10`)</p>	<p>E/BLOP/147</p>
	<p>3.5 m (11`6`")</p>	<p>E/BLOP/148</p>
	<p>4.0 m (13`1`")</p>	<p>E/BLOP/149</p>
	<p>4.5 m (14`9`")</p>	<p>E/BLOP/150</p>
	<p>5.0 m (16`5`")</p>	<p>E/BLOP/151</p>

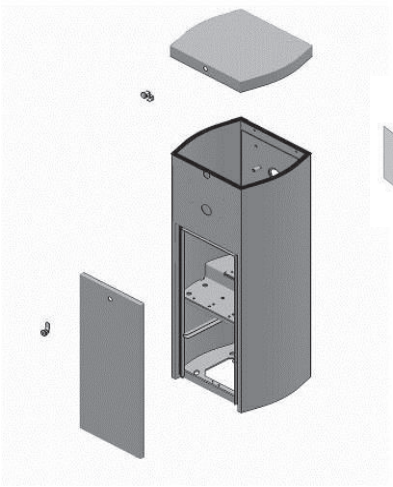
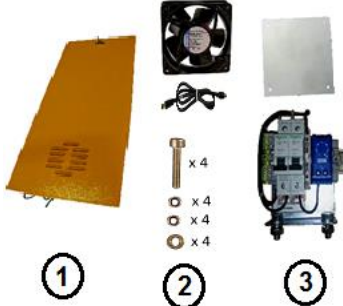
**For more information, please visit [www.devancocanada.com](http://www.devancocanada.com)  
or call toll free at 855-931-3334**

	<p>Frequency Drive 0.75Kw 1Hp Variateur De Fréquence 0.75Kw 1Hp</p>	<p>0/7140/246</p>
	<p><b>HOUSING ASSEMBLY</b> <b>ASSEMBLAGE CARROSSERIE</b></p>	
		
	<p>Hood Lock Assembly Key # 017 Ensemble Serrure Capot Clé # 017</p>	<p>E/1929/088</p>
	<p>Door Assembly Ensemble Porte</p>	<p>E/1929/243</p>
	<p>Door Lock Assembly Key # 017 Ensemble Serrure Porte Clé # 017</p>	<p>E/1929/087</p>
	<p>Lexan Face Panels Assembly Ensemble Faces En Lexan</p>	<p>E/1929/232</p>
	<p>Full Housing Assembly With Lexan Ensemble Carrosserie Arrondie Avec Lexan</p>	<p>E/1929/029</p>
	<p>① Vented Door Assembly Without Cooling Fan Ensemble Porte Ventilée Sans Ventilateur</p>	<p>SA1929/A13</p>
	<p>② BL229 Cooling Fan Assembly Ensemble Ventilateur Pour Porte BL229</p>	<p>SA1929/A14</p>
	<p>①+②+③ BL229 Door With Cooling Fan Option Option Porte BL229 Avec Ventilateur</p>	<p>SA1929/255</p>
	<p>Installation Plate Assembly Ensemble Cadre À Sceller BL229</p>	<p>E/1929/031</p>
	<p>Raised Base Assembly Ensemble Socle De Surélévation</p>	<p>E/BLOP/116</p>

For more information, please visit [www.devancocanada.com](http://www.devancocanada.com)  
or call toll free at 855-931-3334



# MECHANICAL PARTS PIÈCES MÉCANIQUES

	<p>Gearmotor Axis Assembly With Rod End Ensemble Axe Réducteur Avec Chape À Rotule</p>	<p>E/1929/034</p>
	<p>Rod Assembly With Two Rod Ends Ensemble Bielle Avec Deux Chapes À Rotule</p>	<p>E/1929/236</p>
	<p>Left Hand Rod End 5/8'' Chape À Rotule Filet Gauche 5/8''</p>	<p>0/7530/249</p>
	<p>Right Hand Rod End 5/8'' Chape À Rotule Filet Droit 5/8''</p>	<p>0/7530/248</p>
	<p>Axis 1,5'' Assembly With Bearings Ensemble Axe 1,5" Avec Roulements À Paliers</p>	<p>E/1929/235</p>

For more information, please visit [www.devancocanada.com](http://www.devancocanada.com)  
or call toll free at 855-931-3334

	<p>Balance Spring Assembly Ø 5,75 mm (3,0 M And -)</p> <p>Ensemble Ressort D'Équilibrage Ø 5,75 mm (3,0 M Et -)</p>	<p>E/1929/075</p>
	<p>Balance Spring Assembly Ø 7.0 mm (3,5 M And +)</p> <p>Ensemble Ressort D'Équilibrage Ø 7,0 mm (3,5 M Et +)</p>	<p>E/1929/066</p>
	<p>Rod Lever Assembly</p> <p>Ensemble Mâchoire Bielle</p>	<p>E/1929/234</p>
	<p>Spring Lever Assembly</p> <p>Ensemble Mâchoire Ressort</p>	<p>E/1929/233</p>
	<p>Manual Unlocking Assembly</p> <p>Ensemble Déverrouillage Manuel</p>	<p>E/1929/082</p>

For more information, please visit [www.devancocanada.com](http://www.devancocanada.com) or call toll free at 855-931-3334

	<p>Solution 1 Or 2 Bumper Assembly Ensemble Butée Solution 1 Ou 2</p>	<p>E/1929/094</p>
	<p>Solution 3 Or 4 Bumper Assembly Ensemble Butée Solution 3 Ou 4</p>	<p>E/1929/095</p>
	<p>Solution 1 Or 2 Bumper Assembly With Limit Switch Assembly Ensemble Butée Solution 1 Ou 2 Avec Interrupteurs De Fin De Course</p>	<p>E/1929/025</p>
	<p>Solution 3 or 4 Bumper Assembly With Limit Switches Ensemble Butée Solution 3 ou 4 Avec Interrupteurs De Fin De Course</p>	<p>E/1929/067</p>
	<p>Breakaway Kit For Round Arm Option Option Ensemble Dégondable Pour Lisse Ronde</p>	<p>E/BLOP/130</p>

For more information, please visit [www.devancocanada.com](http://www.devancocanada.com)  
or call toll free at 855-931-3334

	<p>Locking Block Assembly For Round Breakaway Arm</p> <p>Ensemble Profile De Blocage Pour Lisse Ronde Dégondable</p>	<p>E/1929/097</p>
	<p>Breakaway Kit For Carbon Arm Option</p> <p>Option Ensemble Dégondable Pour Lisse Protecta</p>	<p>E/BLOP/146</p>
	<p>Locking Block Assembly For Carbon Breakaway Arm</p> <p>Ensemble Profile De Blocage Pour Lisse Protecta Dégondable</p>	<p>E/1929/098</p>
	<p>Breakaway Kit For Oval Arm Option</p> <p>Option Ensemble Dégondable Pour Lisse Ovale</p>	<p>SA1929/A16</p>
	<p>Locking Block Assembly For Oval Breakaway Arm</p> <p>Ensemble Profile De Blocage Pour Lisse Ovale Dégondable</p>	<p>SA1941/B04</p>

For more information, please visit [www.devancocanada.com](http://www.devancocanada.com) or call toll free at 855-931-3334

## GATE ARMS LISSES

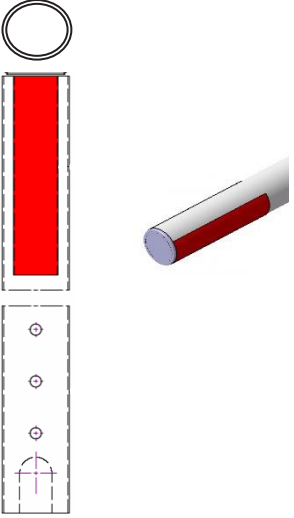
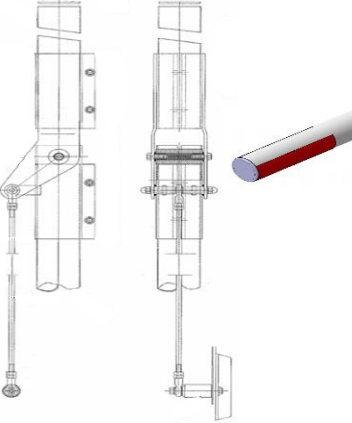
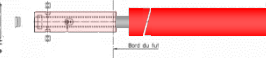
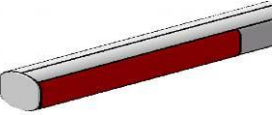
ROUND ARM ASSEMBLY Ø 81 MM ENSEMBLE LISSE RONDE Ø 81 MM		
	ROUND ARM ASSEMBLY 3,05 M ( 10' ) ENSEMBLE LISSE RONDE 3,05 M ( 10' )	E/1929/022
	ROUND ARM ASSEMBLY 3,5 M ( 11' 6'' ) ENSEMBLE LISSE RONDE 3,5 M ( 11' 6'' )	E/1929/068
	ROUND ARM ASSEMBLY 4,0 M ( 13' 1'' ) ENSEMBLE LISSE RONDE 4,0 M ( 13' 1'' )	E/1929/069
	ROUND ARM ASSEMBLY 4,5 M ( 14' 9'' ) ENSEMBLE LISSE RONDE 4,5 M ( 14' 9'' )	E/1929/070
	ROUND ARM ASSEMBLY 5,0 M ( 16' 5'' ) ENSEMBLE LISSE RONDE 5,0 M ( 16' 5'' )	E/1929/071
	ROUND ARM ASSEMBLY 5,5 M ( 18' 1'' ) ENSEMBLE LISSE RONDE 5,5 M ( 18' 1'' )	E/1929/072
	ROUND ARM ASSEMBLY 6,0 M ( 19' 8'' ) ENSEMBLE LISSE RONDE 6,0 M ( 19' 8'' )	E/1929/073
ARTICULATED ROUND ARM ASSEMBLY Ø 81 MM ENSEMBLE LISSE RONDE ARTICULÉE Ø 81 MM		
	ARTICULATED ROUND ARM ASS'Y 3,05 M ( 10' ) ENS. LISSE RONDE ARTICULÉE 3,05 M ( 10' )	EA1929/408
	ARTICULATED ROUND ARM ASS'Y 3,5 M ( 11' 6'' ) ENS. LISSE RONDE ARTICULÉE 3,5 M ( 11' 6'' )	EB1929/408
	ARTICULATED ROUND ARM ASS'Y 4,0 M ( 13' 1'' ) ENS. LISSE RONDE ARTICULÉE 4,0 M ( 13' 1'' )	EC1929/408
	ARTICULATED ROUND ARM ASS'Y 4,5 M ( 14' 9'' ) ENS. LISSE RONDE ARTICULÉE 4,5 M ( 14' 9'' )	ED1929/408
	ARTICULATED ROUND ARM ASS'Y 5,0 M ( 16' 5'' ) ENS. LISSE RONDE ARTICULÉE 5,0 M ( 16' 5'' )	EE1929/408
	3M BREAKAWAY CARBON FIBER PROTECTA ARM ASSEMBLY ENSEMBLE LISSE 3M FIBRE CARBONE PROTECTA™ DÉGONDABLE	E/1929/421
	OVAL-SHAPE SNAP-OUT ARM 3 M ENS. LISSE OVALE DEGONDABLE LG.3.0M	SA1929/020

YOU WILL FIND OTHER GATE OPTIONS IN THE "BL OPTIONS" CATALOG.  
 VOUS TROUVEREZ PLUS D'OPTIONS POUR BARRIÈRES DANS LE CATALOGUE BL OPTIONS".

For more information, please visit [www.devancocanada.com](http://www.devancocanada.com)  
 or call toll free at 855-931-3334

***HOW TO ORDER  
REPAIR PARTS***

**DEVANCO CANADA**

19192 HAY ROAD, UNIT Q  
SUMMERSTOWN, ON K0C 2E0

TOLL FREE: 855-931-3334

[www.devancocanada.com](http://www.devancocanada.com)

**WHEN ORDERING REPAIR PARTS  
PLEASE SUPPLY THE  
FOLLOWING INFORMATION:**

- ✓ PART NUMBER
- ✓ DESCRIPTION
- ✓ MODEL NUMBER