

WIRELESS KEYLESS ENTRY • MODEL M13-631



The **Wireless Keyless Entry System** offers you the convenience of opening and closing your garage door by entering your own 4-digit Personal Identification Number (PIN) via the keypad. The WKE can be programmed wireless to control up to 4 garage door operators that each work on a different code, or to control one garage door operator with up to 4 different PINs. You can also program it to allow a temporary PIN of your choice to be stored, to provide temporary access to authorized visitors or service persons. Check the box content to familiarize yourself with parts shown in Fig.1 and 2.

Other Features Include:

Wireless Installation, Wireless Programming, Low Battery Indication, One-Button-to-Close Operation, Backlit Keypad, Code Security, Anti-Tampering, and Weather-Resistant Design.

! WARNING !

To prevent possible *SERIOUS INJURY* or *DEATH* from a moving gate or garage door:

- **Install Wireless Keyless Entry System within sight of the garage door, out of reach of children at a minimum height of 5 feet (1.5m) and away from ALL moving parts of the door.**
- **ALWAYS keep remote controls out of reach of children. NEVER permit children to operate, or play with remote controls.**
- **Activate gate or door ONLY when it can be seen clearly, is properly adjusted, and there are no obstructions to door travel.**
- **ALWAYS keep gate or garage door in sight until completely closed. NEVER permit anyone to cross path of moving gate or door.**

PROGRAM PIN AND TRANSFER TRANSMITTER CODE

1 Install batteries provided, see Fig. 2.

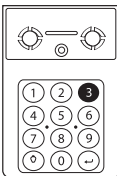

Press and hold **3** button for at least 3 seconds to activate programming mode, **LED's light up for 10 seconds.**

2

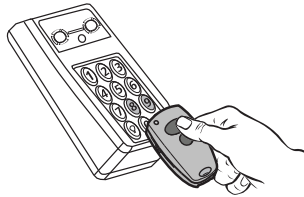

Hold transmitter very close to keypad buttons **8** and **9**. Press and hold transmitter button you use to open and close your garage door. **Release transmitter button when LED's on keypad flash.**

3



Enter a 4-digit personal identification number (PIN) of your choice **###**.

4 Press and release the **ENTER** button.

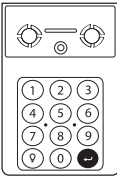

LED's and keypad buttons will light up for 2 seconds signaling programming is completed.

5

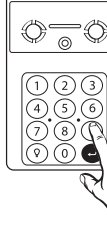

Test WKE by entering the PIN, then press **ENTER** button.

NOTE: To program the WKE to more than one garage door operator (maximum 4), repeat the steps above using a new PIN for each additional garage door operator.

CHANGE AN EXISTING PIN

1

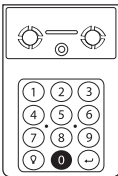

Press **0** button for at least 3 seconds, **LED's will flash slowly.** Release **0** button.

2

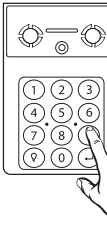

Enter the programmed PIN that you want to change. Press the **ENTER** button. **LED's will flash rapidly.**

3

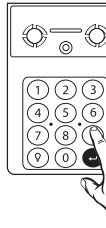

Enter the new 4-digit PIN of your choice **###** then press the **ENTER** button. **LED's and keypad light up for 2 seconds.**

4

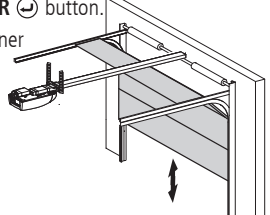

To test WKE, enter the new PIN then press the **ENTER** button. The garage door opener will activate.

For more information, please visit www.devancocanada.com or call toll free at 855-931-3334

PROGRAM A TEMPORARY PIN

A temporary 4-digit PIN can be programmed to allow access to visitors. Each programmed PIN can program one temporary PIN. The temporary PIN can be set for a number of door openings (max 99). The temporary PIN cannot be the same as any previously programmed PIN.

1 Press **1** button for at least 3 seconds. **LED's will flash slowly for 10 seconds.**

NOTE: To successfully establish a temporary pin, steps 2-4 must be completed within 10 seconds after programming activation.

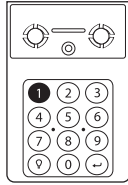

2 Enter any programmed PIN, then press **ENTER** button. **LED's will flash rapidly.**



3 Enter the temporary 4-digit PIN of your choice #### then press the **ENTER** button. **LED's will flash very rapidly.**



4 Press the number of openings the temporary PIN will work (up to 99). Then press the **ENTER** button.

LED's and key pad buttons light up for 2 seconds then system goes in stand-by mode.

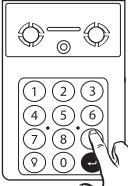

To test, enter the temporary PIN, then press the ENTER button. The garage door operator will activate. If the temporary PIN was set for a number of openings, the test will use up one opening programmed PIN.

NOTE: To clear the temporary PIN, repeat steps 1-3 above, setting the number of openings to "0" in step 4.

INSTALLATION

- 1** Select a location to mount the Keyless Entry at a minimum height of 5 feet (1.5m) out of the reach of children.
- 2** Use mounting plate as template, mark hole location and then drill two 1/8 inch (3.2mm) pilot holes.
- 3** Secure plate to the mounting surface with the (2) screws provided. Do not over-tighten screws to avoid cracking the plastic.
- 4** Cover batteries with battery cover.
- 5** Snap WKE into the mounting plate and secure with screw provided. See Fig. 1.
- 6** Install slide-up protective cover. Align cover slides with slide grooves on WKE and slide cover down until it locks.

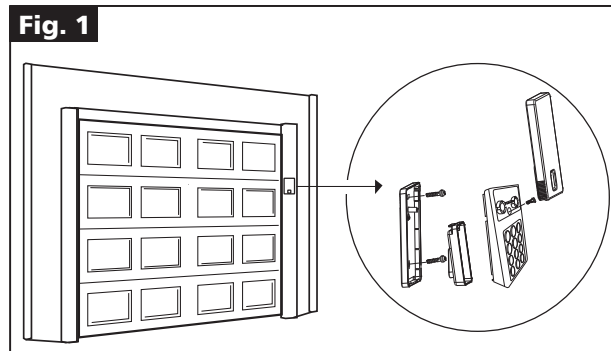

OPERATION

The garage door operator activates when the PIN and **ENTER** button are pressed. The keypad will blink for 28 seconds, during that time the **ENTER** button can be used to stop, start, reverse the door.

If the wrong number is accidentally pressed, press the correct PIN then the **ENTER** button. The Keyless Entry will transmit only the last four digits.

ONE-BUTTON-TO-CLOSE: The Keyless Entry has a feature that allows the door to be closed using the ENTER button instead of a PIN.

NOTE: Factory setting-active.

To deactivate the one button close feature:

- 1** Press the **8** button for 3 seconds. LED on keypad flash slowly.
- 2** Press the **ENTER** button.
- 3** The keypad LED's light up for 2 seconds indicating that the one button close feature has been deactivated.

To activate the one button close feature:

- 1** Press the **9** button for 3 seconds. LED on keypad flash slowly.
- 2** Press the **ENTER** button.
- 3** The keypad LED's light up for 2 seconds indicating that the one button close feature has been activated.

CLEARING WKE Memory

- 1** Remove Wireless Keyless from wall mounting plate.
- 2** Remove batteries from Wireless Keyless.
- 3** Press and hold **ENTER** button.
- 4** Install batteries back. Match polarity designation.
- 5** Release **ENTER** button, LED flash rapidly approximately 5 seconds.

BATTERY

⚠ WARNING ⚠

To prevent possible **SERIOUS INJURY** or **DEATH:**
NEVER allow small children near batteries.
 If battery is swallowed, immediately notify doctor.

Low Battery Indicator:

Replace the batteries when all the keypad buttons start to flash (10 seconds) upon raising the Wireless Keyless protective cover.

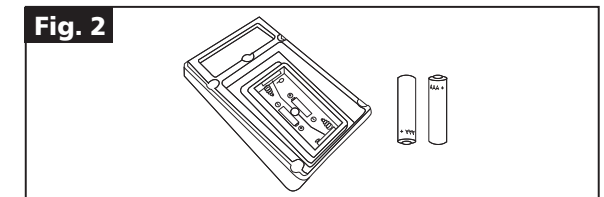

REPLACEMENT PARTS

Battery - AAA (Qty 2)
Keypad cover - (Call customer service)

HOW TO ORDER REPAIR PARTS

DEVANCO CANADA

19192 HAY ROAD, UNIT Q
SUMMERSTOWN, ON K0C 2E0

TOLL FREE: 855-931-3334
www.devancocanada.com

**WHEN ORDERING REPAIR PARTS
PLEASE SUPPLY THE FOLLOWING INFORMATION:**

- ✓ **PART NUMBER**
- ✓ **DESCRIPTION**
- ✓ **MODEL NUMBER**