

### SPECIFICATIONS

**SUPPLY VOLTAGE: 12-24 VOLTS AC OR DC**

**OPERATING CURRENT: 250 mA MAXIMUM**

**OPERATING TEMP RANGE: -40 TO +149F  
(-40 TO +65C)**

**FREQUENCY: 390 MHz STAR450 - 390  
315 MHz STAR450 - 315**

**RELAY CONTACT RATING: 1 AMP @ 24 VOLTS AC OR DC**

### INSTALLATION

1. Select a convenient location near your device to be controlled by the STAR450.
2. Mount the STAR450 in the "Line-Of-Sight" of the intended transmitting location.

**NOTE:** Avoid mounting the STAR450 in or on metallic enclosures. See Remote Antenna Mounting for proper installation.

3. Mount back plate to desired surface using hardware #6 (not provided). Hardware used will depend on mounting application (refer to Figure 1 for receiver mounting hole locations).
4. Wire electrical connections to unit. Snap receiver to back plate.
5. Install the provided antenna onto the receiver antenna connector by screwing the connector clockwise.
6. Slide the seal boot down to meet the o-ring, covering the antenna hardware.

### ⚠️ WARNING

To prevent possible SERIOUS INJURY or DEATH from electrocution:

- Be sure power is not connected BEFORE installing the receiver.

To prevent possible SERIOUS INJURY or DEATH from a moving gate or garage door:

- ALWAYS keep remote controls out of reach of children. NEVER permit children to operate, or play with remote controls.
- Activate gate or door ONLY when it can be seen clearly, is properly adjusted, and there are no obstructions to door travel.
- ALWAYS keep gate or garage door in sight until completely closed. NEVER permit anyone to cross path of moving gate or door.

### Remote Antenna Mounting:

Use the optional 86LM antenna extension kit to mount the remote antenna as high and far from metal as possible for best radio range (Figure 2). Contact technical support at: 1-800-528-2806 to order the model 86LM.

### Features

#### Digital Display

Displays remote control location numbers when programming or access is granted. Also displays user prompts and messages.

#### Delete Key

Used to delete a remote control from the selected memory location

#### Add Key

Used to enter remote controls and enter RAPID LEARN™ mode.

#### Star Key

Used to enter advanced functions:  
 \* 1- Last Remote Control Received  
 \* 2- No. Of Unused Memory Locations  
 \* 3- No. Of Occupied Memory Locations  
 \* 4- No. Of Blocked Remote Control Locations  
 \* 5- First Blocked Remote Control Location  
 \* 7- Software Ver. #  
 \* 0- Audible Diagnostics Off/On

#### Power Indicator

Scrolling dashes on digital display when ac or dc power is applied to the unit.

#### Antenna Connection

For connection to the direct antenna or the antenna extension kit.

#### Block Key

Used to block the receiver from granting access to the selected remote control. Remote control remains in memory, and may be unblocked in the future.

#### Numeric Keypad

Used for programming and querying remote control locations. Also used to enter advanced functions.

#### Pound Key

Used as an esc or exit key for all functions or modes..

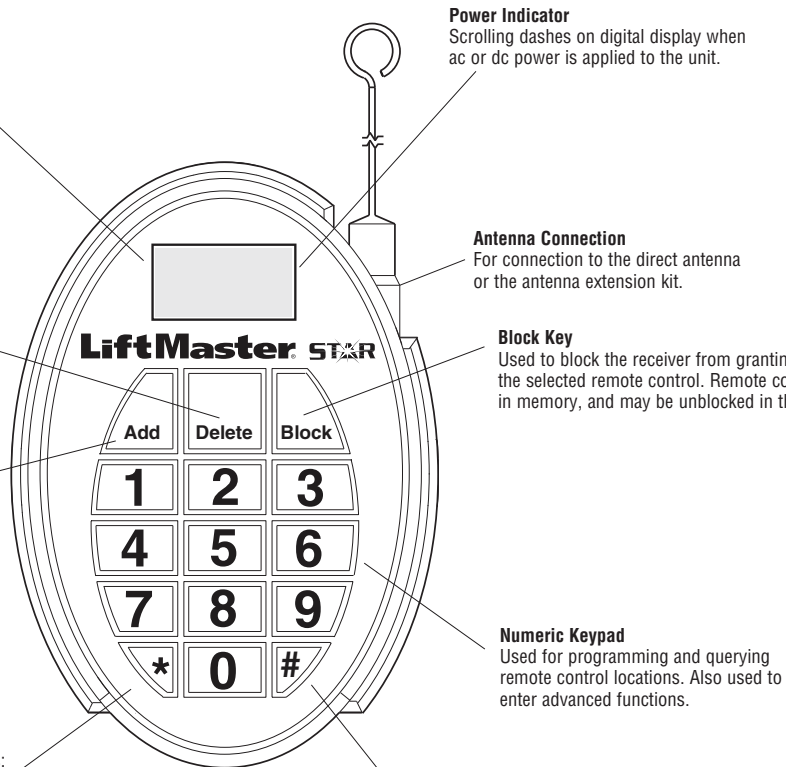

Figure 1

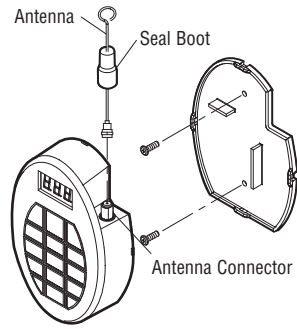
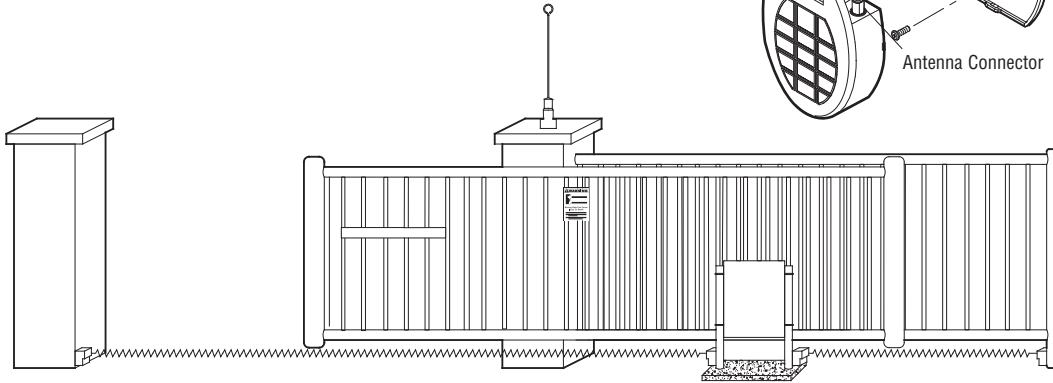
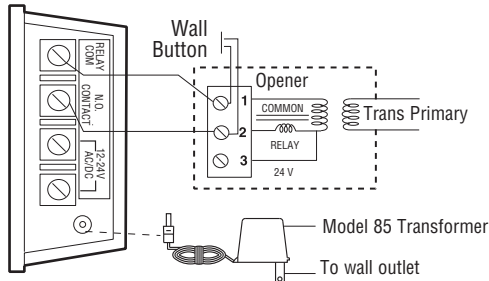

Figure 2



## WIRING

Receiver (Bottom)



Receiver (Bottom)

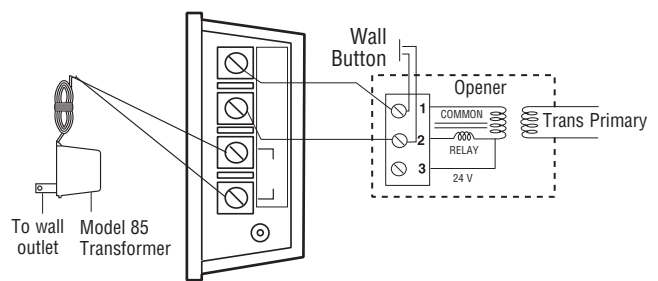

## PROGRAMMING

**Rapid Learn™:** Add remote control to next available location.

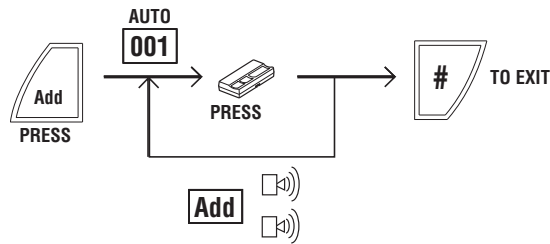

**Adding Remote Control:** Add remote control to a specific location.

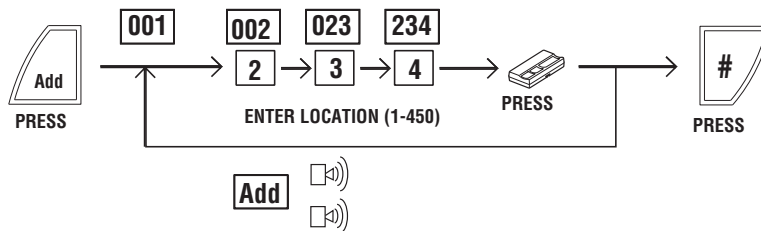

**Deleting a Remote Control:** To delete a user.

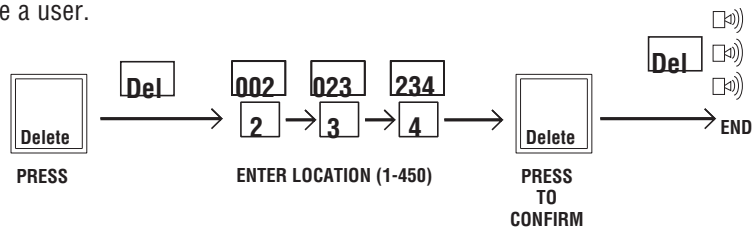

# PROGRAMMING

**Blocking (Unblocking) a Remote Control:** To block or unblock a user.

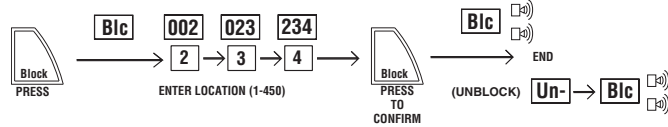

**Duplicating Memory:** Allows user to backup programmed remote control memory into the provided backup memory module.

**NOTE:** If two memory modules are installed, press \*,6 to duplicate the memory and remove the backup module.

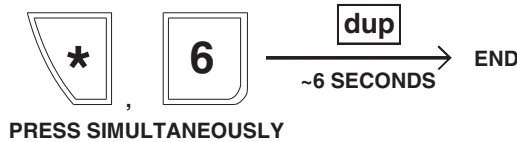

**NOTE:** To duplicate memory, plug backup memory module into backup slot and press \*,6. Once duplication is complete, remove the backup memory module and store in a separate location.

**Restoring Memory:** To restore memory, simply place the duplicate memory module in the main memory position.

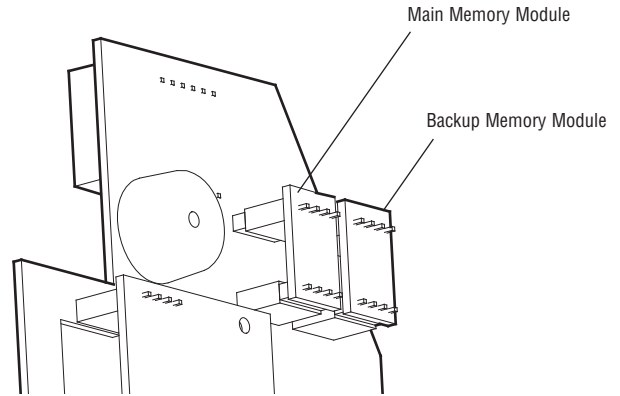

## ADVANCED FUNCTIONS

For advanced functions, press and hold the \* key and a number key at the same time to select the corresponding advanced function. (See table at right for available functions.) Press the # key to exit the function.

- \* 1 Memory location of last remote control received.
- \* 2 # of open remote control locations.
- \* 3 # of locations occupied.
- \* 4 # of blocked remote control locations.
- \* 5 First blocked remote location.
- ↳ 5 Next blocked location (Repeat to scroll).
- \* 6 Duplicate memory- See Duplicating memory.
- \* 7 Version #
- # Press to exit functions.
- \* 0 Audible diagnostics OFF/ON (LED will be displayed when OFF)

\* If no remote controls are programmed into the STAR450, then (---) will be displayed.

## AUDIBLE DIAGNOSTICS

**NOTE:** The receiver will beep if it receives a signal from an unprogrammed remote control. The "Audible diagnostics OFF/ON" feature will disable the beeper, however, the beeper will remain active for all other functions.

**Step 1.** Activate remote control.

**Step 2.** Listen for beep.

(LED will be displayed when OFF)



- ☐) **Double Beep:** Remote control is valid and programmed into STAR450 accompanied by remote control location display.
- ☐) **Slow Beep:** Security+® Remote control (Not programmed in STAR450).
- ☐) **Long Beep:** Blocked remote control.
- ☐) **No Beep:** Remote control not working.

## KEYPAD SOUND ALERTS

- ☐) **Single Beep:** Key pressed.
- ☐) **Double Beep:** Confirmation of an accepted Tx or valid add/block input.

- ☐) **Triple Beep:** Confirmation of delete.
- ☐) **Long Beep:** Blocked Tx, error, or out of range

## REMOTE CONTROL LOCATION QUERY

Enter a remote control location number (001-450) to view location status (see table to the right for possible status displays).

Display	Description	Beeper
OPn	Remote control location is empty	no beep
Occ	Remote control location is occupied	no beep
Blc	Remote control location is blocked	no beep
Out	Remote control location is out of range(not between 1 & 450)	long beep

# TROUBLESHOOTING GUIDE

Problem	Probable Cause(s)	Solution(s)
No display	1. Faulty/intermittent power connections to receiver <b>Or</b> 2. No power to receiver	1. Check power connections to receiver 2. Supply power to receiver
No beep when transmitting	Audible diagnostics may have been turned OFF (right-most decimal point will be lit on the display)	Press * and 0 keys at the same time
Remote control does not activate operator	1. Transmitter not learned into system <b>Or</b> 2. Transmitter is blocked <b>Or</b> 3. Transmitter battery is dead	1. Add remote control to memory 2. Replace remote control battery
Remote control will not learn into memory	1. Memory may be full <b>Or</b> 2. Remote control may not be a recognized Chamberlain remote control <b>Or</b> 3. Remote control battery is dead	1. Delete unused remote controls from memory 2. Verify remote control is listed in compatible Remote controls section <b>Or</b> 3. Replace remote control battery
Receiver does not function, [E 1] displayed	Main memory module missing or damaged	Replace main memory module
Duplication function does not work, [E 2] displayed	Backup memory module missing or damaged, if included	Replace backup memory module
Keypad does not respond, [E 3] displayed	Keypad has a stuck key	Cycle power. If receiver exhibits this condition again after 2 minutes, contact Technical Support.

## Compatible Remote Controls

Security+® Remote Controls	Security+® Keypads
970LM	976LM
971LM	
972LM	
973LM	
974LM	
Passport™ Remote Control	Digital Remote Controls
CPT1	61LM
CPT2	62LM
CPT3	63LM
CPT4	33LM
Passport™ Mini Remote Control	
CPTK1	
CPTK1PH	
CPTK3	
CPTK3PH	

For highest level of security, we recommend the Security+® and Passport™ remote control families.

Security+® Remote Controls	Security+® Keypads
373P	377LM
371LM	379LM
372LM	
370LM	
373LM	
374LM	
Passport™ Remote Control	Digital Remote Controls
CPT43	361LM
CPT13	362LM
CPT23	363LM
CPT33	333LM
Passport™ Mini Remote Control	
CPTK13	
CPTK13PH	
CPTK33	
CPTK33PH	

For highest level of security, we recommend the Security+® and Passport™ remote control families.

## Optional Accessories

CGI Part Number	Description
71-65WTBOX	Watertight Box Field Install Kit
86LM	Antenna Extension Kit
85LM	24VAC Transformer with Barrel Connector
95LM	24VAC Transformer with Screw Terminals

NOTICE: To comply with FCC and/or Industry Canada rules (IC), adjustment or modifications of this receiver and/or transmitter are prohibited, except for changing the code setting or replacing the battery. THERE ARE NO OTHER USER SERVICEABLE PARTS.

Tested to Comply with FCC Standards FOR HOME OR OFFICE USE. Operation is subject to the following two conditions: (1) this device may not cause harmful interference, and (2) this device must accept any interference received, including interference that may cause undesired operation.

## ***HOW TO ORDER REPAIR PARTS***

### **DEVANCO CANADA**

19192 HAY ROAD, UNIT Q  
SUMMERSTOWN, ON K0C 2E0

TOLL FREE: 855-931-3334  
[www.devancocanada.com](http://www.devancocanada.com)

**WHEN ORDERING REPAIR PARTS  
PLEASE SUPPLY THE FOLLOWING INFORMATION:**

- ✓ PART NUMBER**
- ✓ DESCRIPTION**
- ✓ MODEL NUMBER**